

PR
electronics

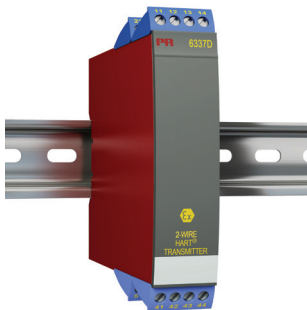

6 3 3 7

**2-wire HART®
Transmitter**

No. 6337V102-UK
From ser. no. 110944345



- DK** ▶ PR electronics A/S tilbyder et bredt program af analoge og digitale signalbehandlingsmoduler til industriel automation. Programmet består af Isolatorer, Displays, Ex-barrierer, Temperaturtransmittere, Universaltransmittere mfl. Vi har modulerne, du kan stole på i selv barske miljøer med elektrisk støj, vibrationer og temperaturudsving, og alle produkter opfylder de strengeste internationale standarder. Vores motto »Signals the Best« er indbegrebet af denne filosofi - og din garanti for kvalitet.
- UK** ▶ PR electronics A/S offers a wide range of analog and digital signal conditioning devices for industrial automation. The product range includes Isolators, Displays, Ex Interfaces, Temperature Transmitters, and Universal Devices. You can trust our products in the most extreme environments with electrical noise, vibrations and temperature fluctuations, and all products comply with the most exacting international standards. »Signals the Best« is the epitome of our philosophy - and your guarantee for quality.
- FR** ▶ PR electronics A/S offre une large gamme de produits pour le traitement des signaux analogiques et numériques dans tous les domaines industriels. La gamme de produits s'étend des transmetteurs de température aux afficheurs, des isolateurs aux interfaces SI, jusqu'aux modules universels. Vous pouvez compter sur nos produits même dans les conditions d'utilisation sévères, p.ex. bruit électrique, vibrations et fluctuations de température. Tous nos produits sont conformes aux normes internationales les plus strictes. Notre devise »SIGNALS the BEST« c'est notre ligne de conduite - et pour vous l'assurance de la meilleure qualité.
- DE** ▶ PR electronics A/S verfügt über ein breites Produktprogramm an analogen und digitalen Signalverarbeitungsgeräte für die industrielle Automatisierung. Dieses Programm umfasst Displays, Temperaturtransmitter, Ex- und galvanische Signaltrenner, und Universalgeräte. Sie können unsere Geräte auch unter extremen Einsatzbedingungen wie elektrisches Rauschen, Erschütterungen und Temperaturschwingungen vertrauen, und alle Produkte von PR electronics werden in Übereinstimmung mit den strengsten internationalen Normen produziert. »Signals the Best« ist Ihre Garantie für Qualität!

2-WIRE HART® TRANSMITTER

PRETRANS 6337

CONTENTS

Application.....	2
Technical characteristics.....	3
Mounting / installation / programming.....	3
Applications.....	4
Ordering codes for 6337	5
Technical data	5
Accessories	5
Changing the HART® protocol version.....	8
Changing the HART protocol version using the PReset software and 5909 Loop Link or HART communication interface.....	9
HARTREV7.....	10
-CHANGE-	10
Connections	12
Block diagram.....	14
Programming	15
Connection of transmitters in multidrop mode.....	17
Appendix	18
ATEX Installation Drawing - 6337A	19
IECEX Installation Drawing - 6337A.....	21
ATEX Installation Drawing - 6337D	23
IECEX Installation Drawing - 6337D.....	25
FM Installation Drawing - 6337D.....	27
CSA Installation Drawing - 6337D	28

PRETRANS 6337

2-WIRE HART® TRANSMITTER

- *RTD, TC, Ohm, or mV input*
- *2 analogue inputs and 5 device variables with status available*
- *HART® protocol revision selectable from HART® 5 or HART® 7*
- *Hardware assessed for use in SIL applications*
- *Mounting on a DIN rail in safe area or hazardous gas and dust area*

Application

- Linearised temperature measurement with TC and RTD sensors e.g Pt100 and Ni100.
- HART® communication and 4...20 mA analogue PV output for individual, difference or average temperature measurement of up to two RTD or TC input sensors.
- Conversion of linear resistance to a standard analogue current signal, e.g from valves or Ohmic level sensors.
- Amplification of bipolar mV signals to standard 4...20 mA current signals.
- Up to 63 transmitters (HART® 7) can be connected in a multidrop communication setup.

Technical characteristics

- HART® protocol revision can be changed by user configuration to either HART® 5 or HART® 7 protocol.
- The HART® 7 protocol offers:
 - Long Tag numbers of up to 32 characters.
 - Enhanced Burst Mode and Event notification with time stamping.
 - Device variable and status mapping to any dynamic variable PV, SV, TV or QV.
 - Process signal trend measurement with logs and summary data.
 - Automatic event notification with time stamps.
 - Command aggregation for higher communication efficiency.
- 6337 is designed according to strict safety requirements and is therefore suitable for applications in SIL installations.
- Continuous check of vital stored data.
- Meeting the NAMUR NE 21 recommendations, the 6337 HART transmitter ensures top measurement performance in harsh EMC environments. Additionally, the 6337 meets NAMUR NE43 and NE89 recommendations.

Mounting / installation / programming

- DIN rail mounting with up to 84 channels per metre.
- Configuration via standard HART® communication interfaces or by PR 5909 Loop Link.
- NB: As Ex barrier for 6337D we recommend 5106B and 9106B.



APPLICATIONS

RTD to 4...20 mA

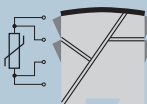

2-wire installation
in control room



TC to 4...20 mA

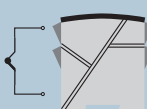

2-wire installation
in control room



Resistance
to 4...20 mA

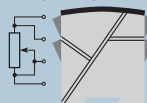

2-wire installation
in control room



mV to 4...20 mA

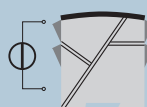

2-wire installation
in control room



Difference or average
RTD, TC or mV

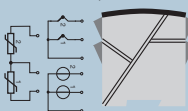

2-wire installation
in control room



Ordering codes for 6337

Type	Version	Galvanic isolation	Channels
6337	Standard : A	1500 VAC : 2	Single : A
	ATEX, CSA, FM & IECEx : D		Double : B

Accessories

5909 = Loop Link USB interface and PRreset Software
 5910 / 5910Ex = CJC connector for channel 1
 5913 / 5913Ex = CJC connector for channel 2

Technical data

Environmental conditions:

Specifications range -40°C to +60°C
 Storage temperature -40°C to +85°C
 Calibration temperature 20...28°C
 Relative humidity < 95% RH (non-cond.)
 Protection degree IP20

Mechanical specifications:

Dimensions (HxWxD) 109 x 23.5 x 104 mm
 Weight approx., 1- / 2-ch. version 150 / 200 g
 DIN rail type DIN EN 60715 - 35mm
 Wire size 0.13...2.08 mm² / AWG
 26...14 stranded wire
 Screw terminal torque 0.5 Nm

Common electrical specifications:

Supply voltage, DC:
 Standard 8.0...35 V
 ATEX, CSA, FM & IECEx 8.0...30 V
 Voltage drop 8.0 V
 Isolation voltage, test / operation 1.5 kVAC / 50 VAC
 Isolation voltage, channel 1 / channel 2:
 Standard 3.75 kVAC
 ATEX, CSA, FM & IECEx 1.5 kVAC

Signal / noise ratio > 60 dB
 Communications interface Loop Link & HART®
 Response time (programmable)..... 1...60 s
 Accuracy, the greater of general and basic values:

General values		
Input type	Absolute accuracy	Temperature coefficient
All	$\leq \pm 0.05\%$ of span	$\leq \pm 0.005\%$ of span / °C

Basic values		
Input type	Basic accuracy	Temperature coefficient
Pt50 - Pt1000	$\leq \pm 0.1^\circ\text{C}$	$\leq \pm 0.005^\circ\text{C}/^\circ\text{C}$
Ni50 - Ni1000	$\leq \pm 0.2^\circ\text{C}$	$\leq \pm 0.005^\circ\text{C}/^\circ\text{C}$
Lin. R	$\leq \pm 0.1 \Omega$	$\leq \pm 5 \text{ m}\Omega / ^\circ\text{C}$
Volt	$\leq \pm 10 \mu\text{V}$	$\leq \pm 0.5 \mu\text{V} / ^\circ\text{C}$
TC type: E, J, K, L, N, T, U	$\leq \pm 0.5^\circ\text{C}$	$\leq \pm 0.025^\circ\text{C} / ^\circ\text{C}$
TC type: B ¹ , Lr, R, S, W3, W5	$\leq \pm 1^\circ\text{C}$	$\leq \pm 0.1^\circ\text{C} / ^\circ\text{C}$
TC type: B ²	$\leq \pm 3^\circ\text{C}$	$\leq \pm 0.3^\circ\text{C} / ^\circ\text{C}$
TC type: B ³	$\leq \pm 8^\circ\text{C}$	$\leq \pm 0.8^\circ\text{C} / ^\circ\text{C}$
TC type: B ⁴	not specified	not specified

TC B¹ accuracy specification range > 400°C
 TC B² accuracy specification range > 160°C < 400°C
 TC B³ accuracy specification range > 85°C < 160°C
 TC B⁴ accuracy specification range < 85°C

TC cold junction compensation < $\pm 1.0^\circ\text{C}$
 Max. offset on input signal 50% of selec. max. value

EMC immunity influence < $\pm 0.1\%$ of span
Extended EMC immunity: NAMUR NE 21, A criterion, burst < $\pm 1\%$ of span

Input specifications:

RTD input types:

RTD type	Min. value	Max. values	Min. span	Standard
Pt100	-200°C	+850°C	10°C	IEC 60751
Ni100	-60°C	+250°C	10°C	DIN 43760
Lin. R	0 Ω	7000 Ω	25 Ω	-----

Pt50, Pt100, Pt200, Pt500, Pt1000, Ni50, Ni100, Ni120, Ni1000

Cable resistance per wire (max.) 5 Ω

(up to 50 Ω per wire is possible with reduced measurement accuracy)

Sensor current..... Nom. 0.2 mA

TC input types:

Type	Min. temperature	Max. temperature	Min. span	Standard
B	0°C	+1820°C	100°C	IEC584
E	-100°C	+1000°C	50°C	IEC584
J	-100°C	+1200°C	50°C	IEC584
K	-180°C	+1372°C	50°C	IEC584
L	-200°C	+900°C	50°C	DIN 43710
Lr	-200°C	+800°C	50°C	GOST 3044-84
N	-180°C	+1300°C	50°C	IEC584
R	-50°C	+1760°C	100°C	IEC584
S	-50°C	+1760°C	100°C	IEC584
T	-200°C	+400°C	50°C	IEC584
U	-200°C	+600°C	50°C	DIN 43710
W3	0°C	+2300°C	100°C	ASTM E988-90
W5	0°C	+2300°C	100°C	ASTM E988-90

Cold junction compensation (CJC):

Constant, internal or external via a Pt100 or Ni100 sensor

mV input:

Voltage input range..... -800...+800 mV

Min. span..... 2.5 mV

Input resistance..... 10 MΩ

Output specifications and HART®:

Signal range.....	4...20 mA
Min. signal range.....	16 mA
Updating time.....	440 ms
Load resistance.....	$\leq (V_{\text{supply}} - 8) / 0.023 [\Omega]$
Sensor error detection, programmable.....	3.5...23mA (shorted sensor error detection is ignored at TC and mV input)
NAMUR NE43 Upscale.....	23 mA
NAMUR NE43 Downscale.....	3.5 mA
HART® protocol revisions.....	HART® 5 and HART® 7

Changing the HART® protocol version

It is possible to change the unit's HART® protocol revision by using the PRreset software and a PR 5909 Loop Link interface or a HART® interface. Other HART® configuration tools like a Handheld HART Terminal may also be used.

Procedure for using a HART® hand-held terminal to change the 6337 from HART® 7 to HART® 5 and vice versa:

Change the 6337 from HART 7 to HART 5:

Drive the 6337 device **Online** and enter **Device setup - Diag/Service**.
Select **"Write protection"** and **Write protect** by entering "*****" (8 stars).
Select **New password** - type "*****" (8 stars) & then **"HARTREV5"**.
Select **Write enable** by entering **"-CHANGE-"**.

Change the 6335 (6337) from HART 5 to HART 7:

Drive the 6335 device **Online** and enter **Device setup - Diag/Service**.
Select **"Write protection"** and **Write protect** by entering "*****" (8 stars).
Select **New password** - type "*****" (8 stars) & then **"HARTREV7"**.
Select **Write enable** and enter **"-CHANGE-"**.

Please note this is only possible if the transmitter is marked "6337" on the label!

Changing the HART protocol version using the PReset software and 5909 Loop Link or HART communication interface

Switching from HART 7 to HART 5:

Select the 6337 product, click the "HART" tab and open the folder "Methods". Click "Device Password / Write Protection / Protocol..." and select "Change protocol to HART 5" in the pop-up window, then acknowledge by pressing OK.

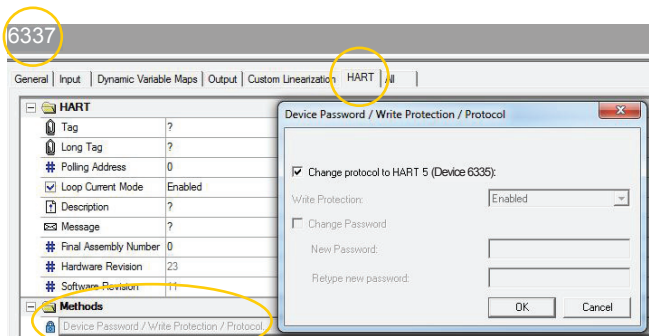

The following message will now appear:

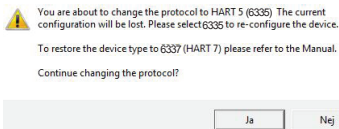

If you press "Ja" (Yes):

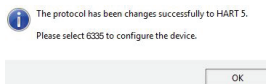

Switching from HART 5 to HART 7:

Please note this is only possible if the transmitter is marked "6337" on the label!

From PReset, select the 6335 product, click the "OPTIONS" tab click "Protect". Write protection must be set to "ON". Select **Change Password**. Type in the **New Password "HARTREV7"** and Re-enter "HARTREV7". Click OK.

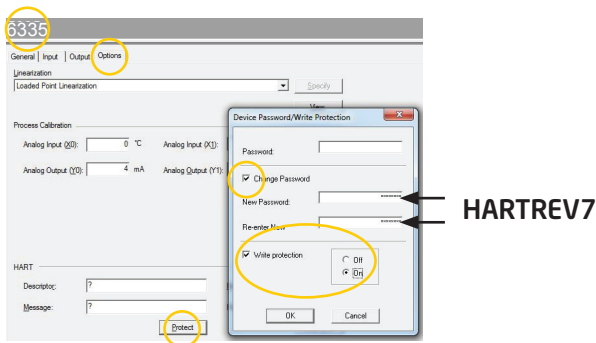

Switch **Write protection OFF** and write-enable the device by typing in the **Password "-CHANGE-"** in the top menu - acknowledge by pressing OK. This action will reset the password to the default active password "*****" (8 stars) and restart the device in the updated HART[®] 7 mode with write protection disabled. Now, select 6337 in PReset and reconfigure the device.

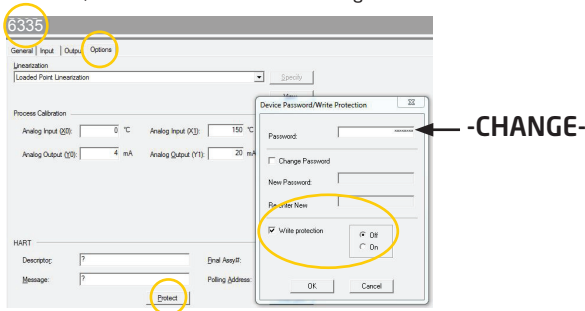

Approvals:

EMC 2004/108/EC EN 61326-1
GOST R

Ex / I.S.:

6337A:

ATEX 94/9/EC KEMA 10ATEX0006 X
IECEX..... KEM 10.0084 X

6337D:

ATEX 94/9/EC KEMA 09ATEX0148
IECEX..... KEM 10.0083 X
FM certificate..... 2D5A7
CSA certificate..... 1125003
GOST Ex

Functional Safety:

Hardware assessed for use in SIL applications
FMEDA report - www.prelectronics.com

CONNECTIONS

Inputs:

Channel 1

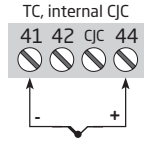
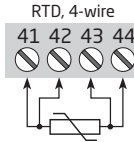
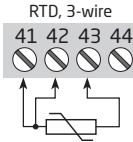
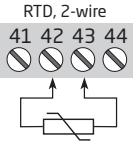

Channel 2

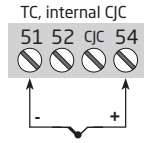
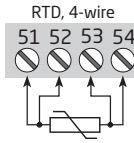
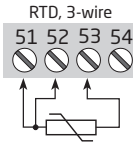
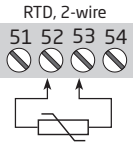

Channel 1

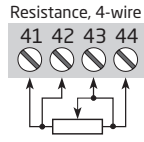
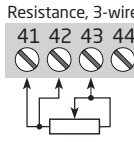
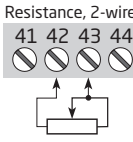
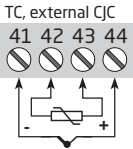

Channel 2

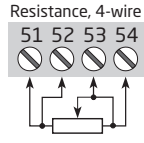
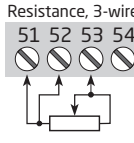
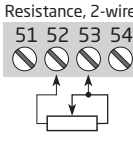
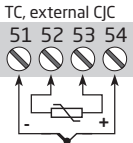

CONNECTIONS

Inputs:

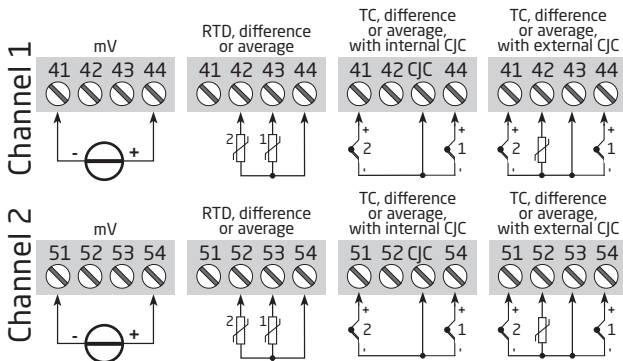

Outputs:

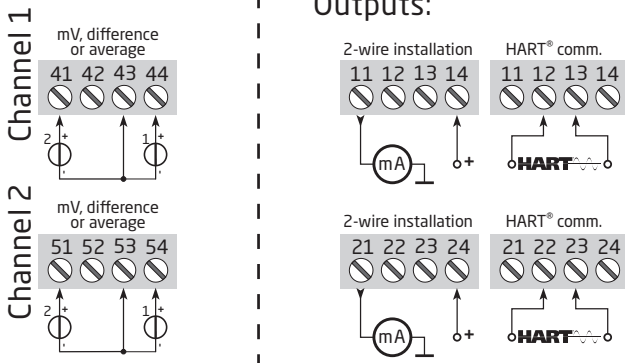

BLOCK DIAGRAM

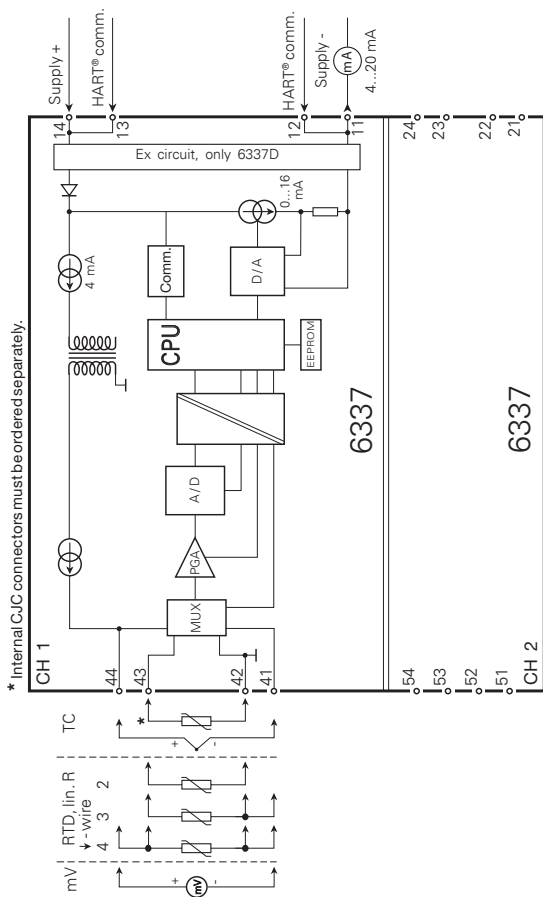

PROGRAMMING

PRetrans 6337 can be configured in the following 3 ways:

1. With PR electronics A/S' communications interface Loop Link and PRreset PC configuration software.
2. With a HART[®] modem and PRreset PC configuration software.
3. With a HART[®] communicator with PR electronics A/S' DDL driver.

1: Loop Link

For programming please refer to the drawing below and the help functions in PRreset.

When communicating with non-installed devices, connectors 11, 12, 13, 14 (channel 1) and 21, 22, 23, 24 (channel 2) can be dismantled in the safe area to connect the terminals of the communications interface to the pins.

Loop Link is not approved for communication with devices installed in hazardous (Ex) area.

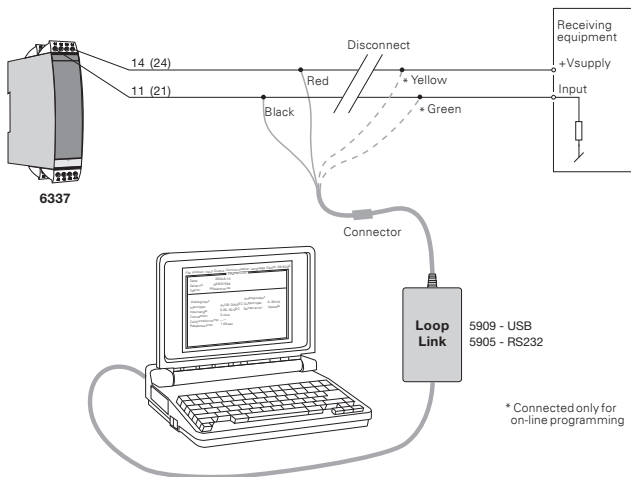

2: HART® modem

For programming please refer to the drawing below and the help functions in PReset.

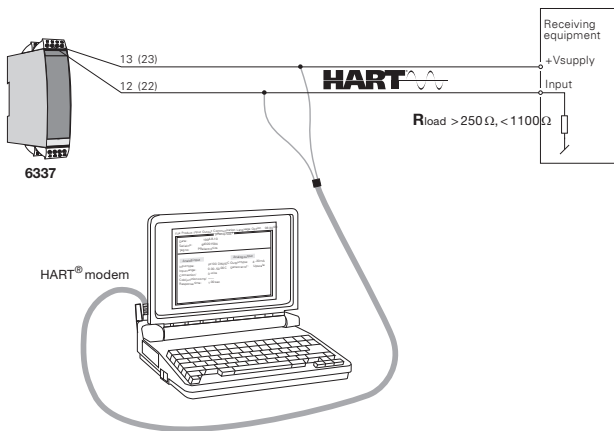

3: HART® communicator

For programming please refer to the drawing below. To get access to product-specific commands, the HART® communicator must be loaded with the PR electronics A/S DDL driver. This can be ordered either at the HART® Communication Foundation or PR electronics A/S.

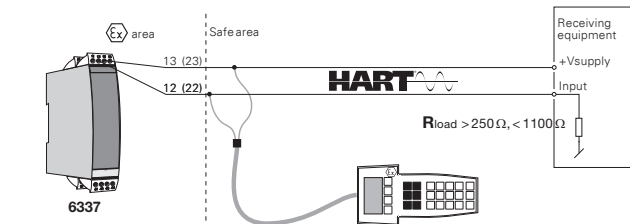

CONNECTION OF TRANSMITTERS IN MULTIDROP MODE

- The HART[®] communicator or a PC modem can be connected across AB or BC.

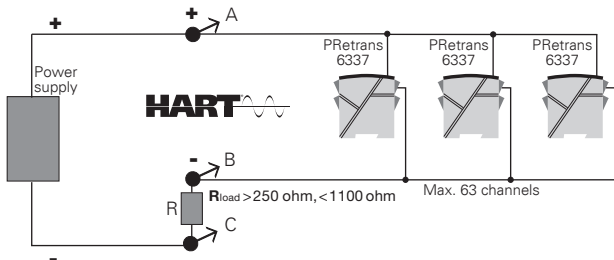

- The outputs of max. 63 transmitters can be connected in parallel for a digital HART[®] communication on 2-wires.
- Before it is connected, each transmitter must be configured with a unique number from 1 to 63. If 2 transmitters are configured with the same number, both will be excluded. The transmitters must be programmed for multidrop mode (with a fixed output signal of 4 mA). Maximum current in the loop is therefore 252 mA.
- The communication is either by means of a HART[®] communicator or a HART[®] modem.
- The PReset PC configuration software can configure the individual transmitter for multidrop mode and provide it with a unique polling address.

APPENDIX

ATEX INSTALLATION DRAWING - 6337A

IECEX INSTALLATION DRAWING - 6337A

ATEX INSTALLATION DRAWING - 6337D

IECEX INSTALLATION DRAWING - 6337D

FM INSTALLATION DRAWING NO. 6335QF01

CSA INSTALLATION DRAWING NO. 6335QC02

ATEX Installation drawing

For safe installation of 6335A, 6336A or 6337A the following must be observed. The module shall only be installed by qualified personnel who are familiar with the national and international laws, directives and standards that apply to this area.

Year of manufacture can be taken from the first two digits in the serial number.

ATEX Certificate KEMA 10ATEX 0006X

Marking



II 3 G Ex nA [ic] IIC T6...T4 Gc
 II 3 G Ex ic IIC T6...T4 Gc
 II 3 D Ex ic IIC Dc

Standards

EN 60079-0 : 2009, EN 60079-11:2007,
 EN 60079-15: 2010, EN 61241-11:2006

T6: -40°C to 60 °C
 T4: -40°C to 85 °C

Hazardous Area Zone 2 or Zone 22

Terminal:
41,42,43,44 /
51,52,53,54

Ex nA [ic]

U_o: 9.6 VDC
 I_o: 28 mA
 P_o: 67 mW
 L_o: 35 mH
 C_o: 3.5 µF

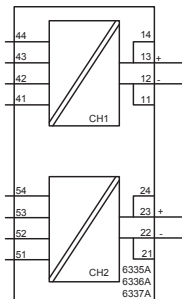

Terminal:
11,12,13,14
21,22,23,24

Ex nA

U ≤ 35 VDC
 I = 4 - 20 mA

Ex ic

U_i: 35 VDC
 L_i: 10 µH
 C_i: 2.0 nF

Special conditions for safe use.

Type of protection Ex ic IIC Gc:

The transmitter shall be installed in an enclosure that provides a degree of protection of at least IP54 according to EN60529.

Type of protection Ex ic IIIC Dc:

The transmitter shall be installed in an enclosure providing a degree of protection of at least IP6X according to EN60529. The surface temperature of the enclosure is equal to the ambient temperature +20 K, for a dust layer with a maximum thickness of 5 mm.

IECEX Installation drawing

For safe installation of 6335A, 6336A or 6337A the following must be observed. The module shall only be installed by qualified personnel who are familiar with the national and international laws, directives and standards that apply to this area.

Year of manufacture can be taken from the first two digits in the serial number.

IECEX Certificate	IECEX KEM.10.0084X
Marking	Ex nA [ic] IIC T6 Gc Ex ic IIC T6 Gc Ex ic IIIC Dc
Standards	IEC60079-11:2006, IEC60079-0: 2007, IEC60079-26:2006, IEC60079-15:2010, IEC61241-11:2005

T6: -40°C to 60 °C

Hazardous Area Zone 2 or Zone 22

Terminal:
41,42,43,44 /
51,52,53,54

Ex nA [ic]

U_o: 9.6 VDC
I_o: 28 mA
P_o: 67 mW
L_o: 35 mH
C_o: 3.5µF

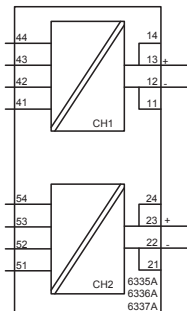

Terminal:
11,12,13,14
21,22,23,24

Ex nA

U ≤ 35 VDC
I = 4 - 20 mA

Ex ic

U_i : 35 VDC
L_i : 10 µH
C_i : 2.0 nF

Installation notes.

Type of protection Ex ic IIC Gc or Ex nA IIC Gc

The transmitter shall be installed in an enclosure that provides a degree of protection of at least IP54 according to IEC60529.

Type of protection Ex ia IIIC Da:

The transmitter shall be installed in an enclosure that provides a degree of protection of at least IP6X according to IEC60529. The surface temperature of the enclosure is equal to the ambient temperature +20 K, for a dust layer with a maximum thickness of 5 mm.

ATEX Installation drawing



For safe installation of 6335D, 6336D or 6337D the following must be observed. The module shall only be installed by qualified personnel who are familiar with the national and international laws, directives and standards that apply to this area.

Year of manufacture can be taken from the first two digits in the serial number.

ATEX Certificate KEMA 09ATEX 0148

Marking



II 1 G Ex ia IIC T6..T5 Ga
II 1D Ex ia IIIC Da

Standards EN60079-0:2009, EN60079-11:2007, EN60079-26:2007, EN61241-11:2006

Hazardous area
Zone 0, 1, 2, 20, 21, 22

T5: $-40 \leq T_a \leq 60^\circ\text{C}$

T6: $-40 \leq T_a \leq 40^\circ\text{C}$

Terminal:

41,42,43,44

Uo: 9.6 VDC

Io: 28 mA

Po: 67 mW

Lo: 35 mH

Co: 3.5µF

Terminal:

51,52,53,54

Uo: 9.6 VDC

Io: 28 mA

Po: 67 mW

Lo: 35 mH

Co: 3.5µF

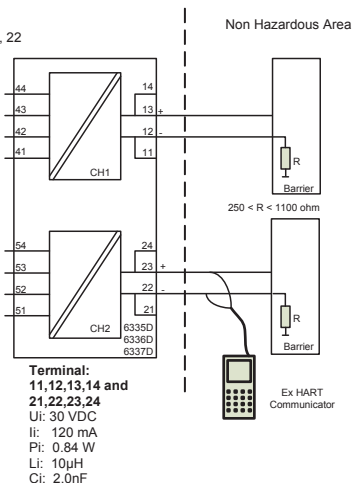

Installation notes

The sensor circuit is not infallibly galvanic isolated from the supply output circuit. However, the galvanic isolation between the circuits is capable of withstanding a test voltage of 500Vac during 1 minute.

Type of protection Ex ia IIC Ga:

The transmitter shall be installed in an enclosure that provides a degree of protection of at least IP20 according to EN60529.

Type of protection Ex ia IIIC Da:

The transmitter shall be installed in an enclosure that provides a degree of protection of at least IP6X according to EN60529. The surface temperature of the enclosure is equal to the ambient temperature +20 K, for a dust layer with a maximum thickness of 5 mm.

IECEX Installation drawing



For safe installation of 6335D, 6336D or 6337D the following must be observed. The module shall only be installed by qualified personnel who are familiar with the national and international laws, directives and standards that apply to this area.

Year of manufacture can be taken from the first two digits in the serial number.

IECEX Certificate	IECEX KEM.10.0084X
Marking	Ex ia IIC T6..T5 Ga Ex ia IIIC Da
Standards:	IEC60079-11:2006, IEC60079-0: 2007, IEC60079-26:2006, IEC61241-11:2005

Hazardous area
Zone 0, 1, 2, 20, 21, 22

T5: $-40 \leq T_a \leq 60^\circ\text{C}$
T6: $-40 \leq T_a \leq 40^\circ\text{C}$

Non Hazardous Area

Terminal:

41,42,43,44
Uo: 9.6 VDC
Io: 28 mA
Po: 67 mW
Lo: 35 mH
Co: 3.5 μ F

Terminal:

51,52,53,54
Uo: 9.6 VDC
Io: 28 mA
Po: 67 mW
Lo: 35 mH
Co: 3.5 μ F

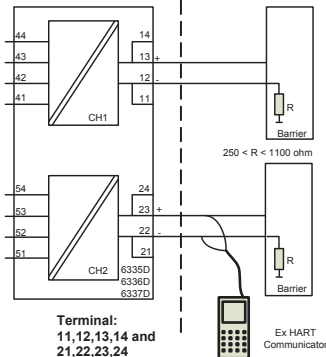

Terminal:
11,12,13,14 and
21,22,23,24
Ui: 30 VDC
Ii: 120 mA
Pi: 0.84 W
Li: 10 μ H
Ci: 2.0nF

Installation notes

The sensor circuit is not infallibly galvanic isolated from the supply output circuit. However, the galvanic isolation between the circuits is capable of withstanding a test voltage of 500Vac during 1 minute.

For installation in dust the following instructions apply:

The transmitter shall be mounted in a metal enclosure that is providing a degree of protection of at least IP6X according to IEC 60529. The surface temperature of the enclosure is equal to the ambient temperature +20 K, for a dust layer with a maximum thickness of 5 mm.

Cable entries and blanking elements shall be used that are suitable for the application and correctly installed

FM Installation drawing

Hazardous (Classified) Location
 Class I, Division 1, Group A,B,C,D
 Class I, Zone 0, IIC

T6: $-40 \leq T_a \leq 60^\circ\text{C}$

Non Hazardous Location

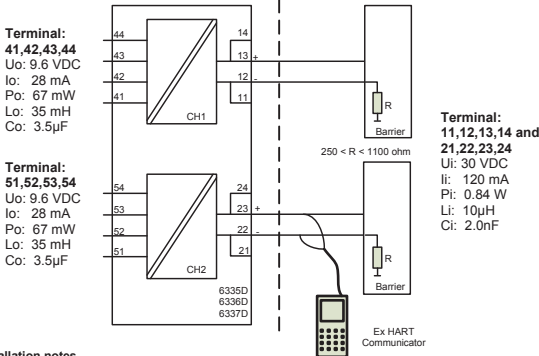

Installation notes.

For installation in Class I the Transmitter must be installed in a suitable enclosure to meet installation codes stipulated in The National Electrical Code (ANSI-NFPA 70).

Equipment that is FM-approved for intrinsic safety may be connected to barriers based on the Entity Concept. This concept permits interconnection of approved transmitters, meters and other devices in combinations, which have not been specifically examined by FM, provided that the agency's criteria are met. The combination is then intrinsically safe, if the entity concept is acceptable to the authority having jurisdiction over the installation.

The entity concept criteria are as follows: The intrinsically safe devices, other than barriers, must not be a source of power. The maximum voltage U_i(V_{MAX}) and current I_i(I_{MAX}), and maximum power P_i(P_{max}), which the device can receive and remain intrinsically safe, must be equal to or greater than the voltage (U_o or V_{OC} or V_I) and current (I_o or I_{SC} or I_I) and the power P_o which can be delivered by the barrier. The sum of the maximum unprotected capacitance (C_i) for each intrinsically device and the interconnecting wiring must be less than the capacitance (C_a) which can be safely connected to the barrier. The sum of the maximum unprotected inductance (L_i) for each intrinsically device and the interconnecting wiring must be less than the inductance (L_a) which can be safely connected to the barrier. The entity parameters U_o, V_{OC} or V_I and I_o, I_{SC} or I_I, and C_a and L_a for barriers are provided by the barrier manufacturer.

CSA Installation drawing

Hazardous (Classified) Location
 Class I, Division 1, Group A,B,C,D
 Class I, Zone 0, IIC

T6: $-40 \leq T_a \leq 60^\circ\text{C}$

Non Hazardous Location

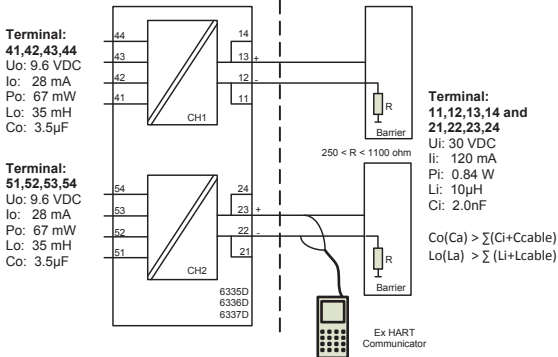

Installation notes.

The Transmitter must be installed in a suitable enclosure to meet installation codes stipulated in The Canadian Electrical Code (CEC).

Channel 1 and Channel 2 are separate channels and therefore separate shielded cables shall be used for each channel.

Substitution of components may impair intrinsic safety.



Displays Programmable displays with a wide selection of inputs and outputs for display of temperature, volume and weight, etc. Feature linearisation, scaling, and difference measurement functions for programming via PReset software.



Ex interfaces Interfaces for analogue and digital signals as well as HART® signals between sensors / I/P converters / frequency signals and control systems in Ex zone 0, 1 & 2 and for some devices in zone 20, 21 & 22.



Isolation Galvanic isolators for analogue and digital signals as well as HART® signals. A wide product range with both loop-powered and universal isolators featuring linearisation, inversion, and scaling of output signals.



























Temperature A wide selection of transmitters for DIN form B mounting and DIN rail devices with analogue and digital bus communication ranging from application-specific to universal transmitters.



Universal PC or front programmable devices with universal options for input, output and supply. This range offers a number of advanced features such as process calibration, linearisation and auto-diagnosis.



- 
 www.preelectronics.fr
 sales-fr@preelectronics.com
- 
 www.preelectronics.de
 sales-de@preelectronics.com
- 
 www.preelectronics.es
 sales-es@preelectronics.com
- 
 www.preelectronics.it
 sales-it@preelectronics.com
- 
 www.preelectronics.se
 sales-se@preelectronics.com
- 
 www.preelectronics.co.uk
 sales-uk@preelectronics.com
- 
 www.preelectronics.com
 sales-us@preelectronics.com
- 
 www.preelectronics.cn
 sales-cn@preelectronics.com

Head office

Denmark
 PR electronics A/S
 Lerbakken 10
 DK-8410 Rønne

www.preelectronics.com
sales-dk@preelectronics.com
 tel. +45 86 37 26 77
 fax +45 86 37 30 85



QUALITY SYSTEM AND ENVIRONMENTAL MANAGEMENT SYSTEM
 DS/EN ISO 9001
 DS/EN ISO 14001

